

Resistance Birds: Hawaii Nene

Foundation Paper Piecing Pattern











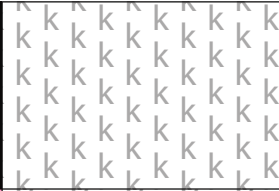

Finished Block: 12 inches x 12 inches

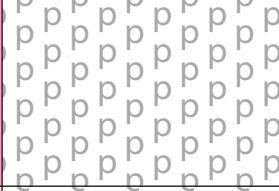
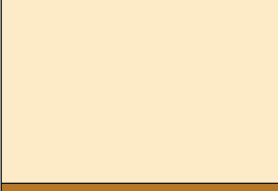
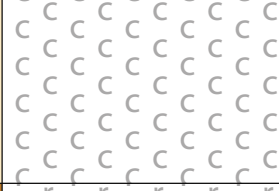

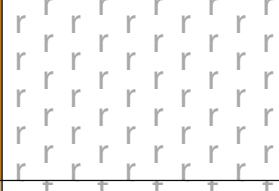
Coffee Town Quilting, LLC

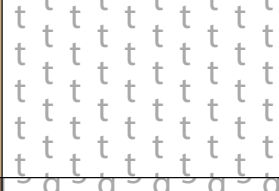
coffeetownquilting.com | @coffeetownquilting

Color Guide and Fabric Chart

Color	Color Code	Yardage	Notes	Sample
		1/2 yard		Paste fabric sample here
		Fat Quarter		Paste fabric sample here
		1/2 yard		Paste fabric sample here
		Fat Quarter		Paste fabric sample here
		Fat Quarter		Paste fabric sample here
		Fat Quarter		Paste fabric sample here
		Fat Quarter		Paste fabric sample here

Recommendations:

- **Since this design has many small pieces to accommodate the bird's details, batik or thinner fabric is recommended for best results.**
- This pattern assumes you already have knowledge of FPP and have completed beginning or intermediate designs.
- Color Guides are on page 2, print in color if able.
 - Cut small swatches of the fabric you will be using for each color code and paste them next to the corresponding square in the Color Guide grids.
 - Keep grid close to your cutting and sewing table as a legend and a reminder of which fabric is used for each color code.
 - The final page of the pattern is a grayscale and outline of the pattern, feel free to print and audition different color schemes according to your preference.
- Print the pattern pieces on newsprint paper if available for easy paper removal.
- Sew straight stitch with stitch length 1.5 - 2.0.
- Use an 80 wt or thinner thread for piecing to help keep seam bulk at minimum.
- In more complex areas with small pieces, consider trimming to 1/8" seam allowance.
- Remove paper backing from seam allowance before ironing when piecing separate sections together, this will help reduce bulk from sections pieced together and make final paper removal easier.
- Instructions and videos with helpful hints how to successfully line up and piece together cross seams across blocks are on my website coffeetownquilting.com.
- Once pieced, remove paper, spray liberally with ironing starch, and press well before adding border and quilting.
- The bird's eye can be added afterward using applique, beads, embroidery, or fabric paint.

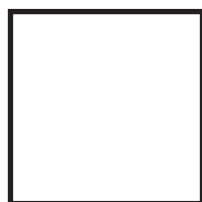

1 inch square:
Measure printed page
to ensure measurement
accuracy

Section Map

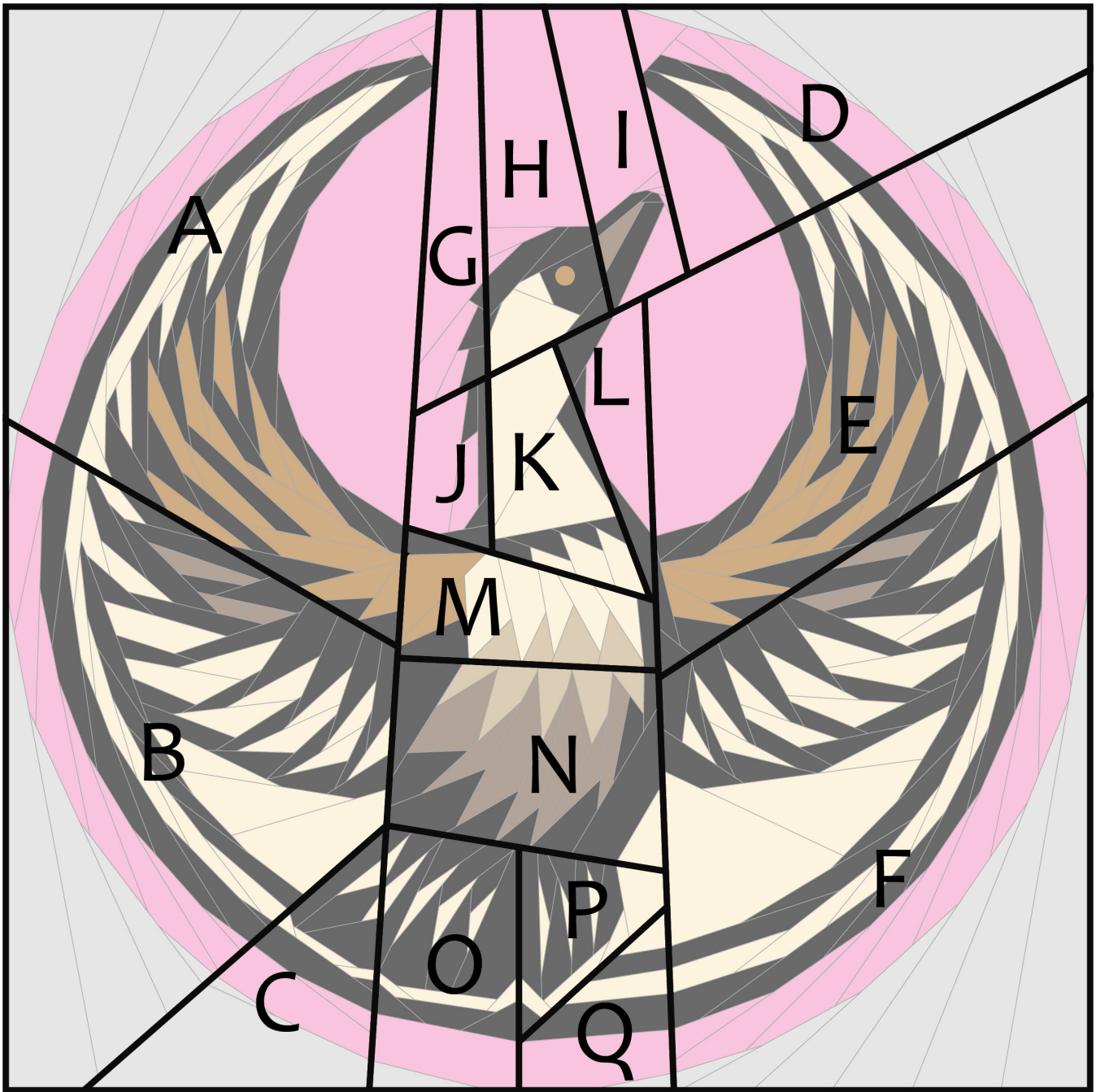

Section 1	Section 2	Section 3	Final Piecing
-----------	-----------	-----------	---------------

1. A + B + C

1. G + H + I + D

1. E + F
2. J + K + L
3. M + N
4. O + (P + Q)
5. JKL + MN + OPQ
6. EF + JKLMNOPQ

1. Section 2 + 3
2. Section 1 +
Sections 2:3

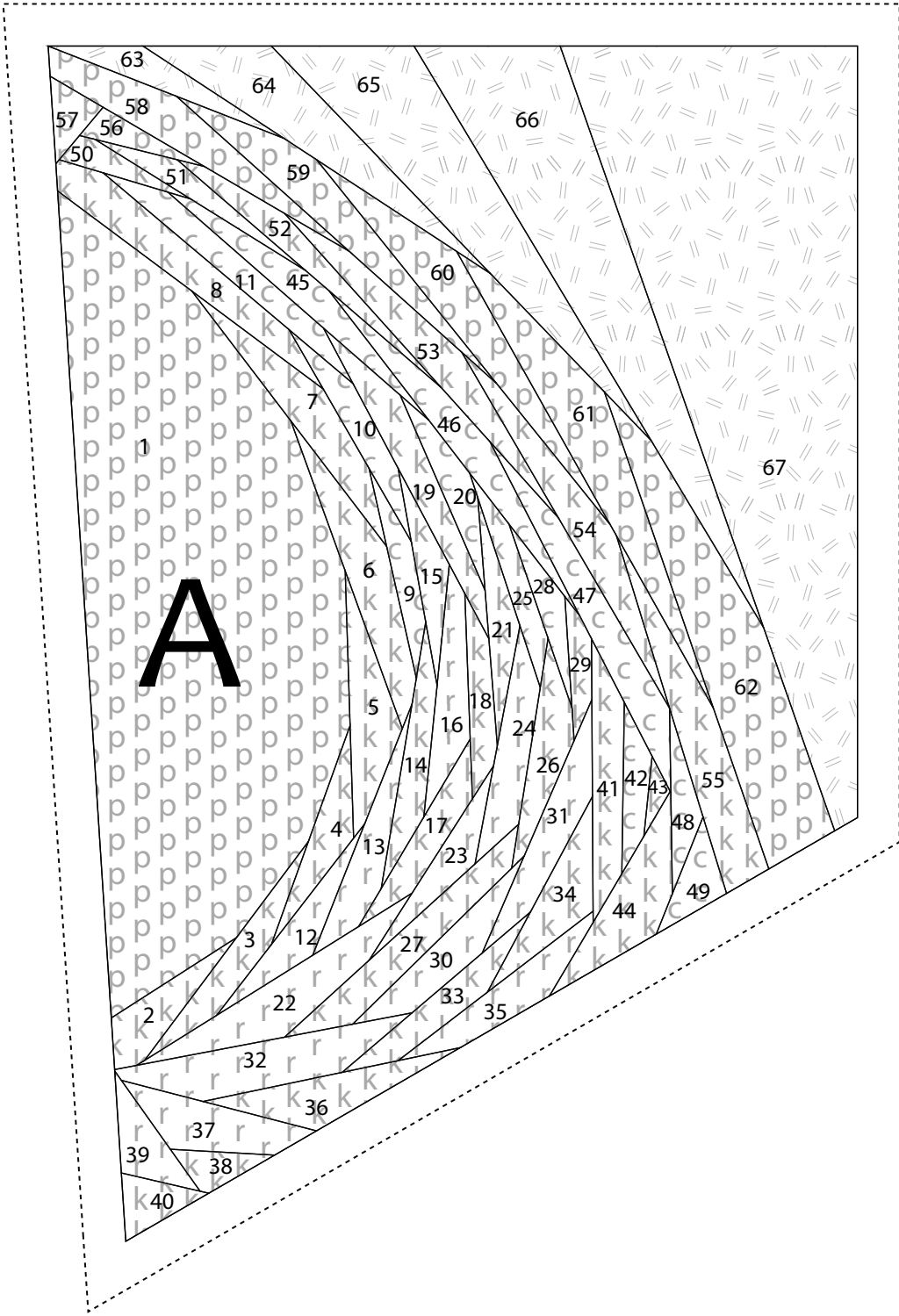

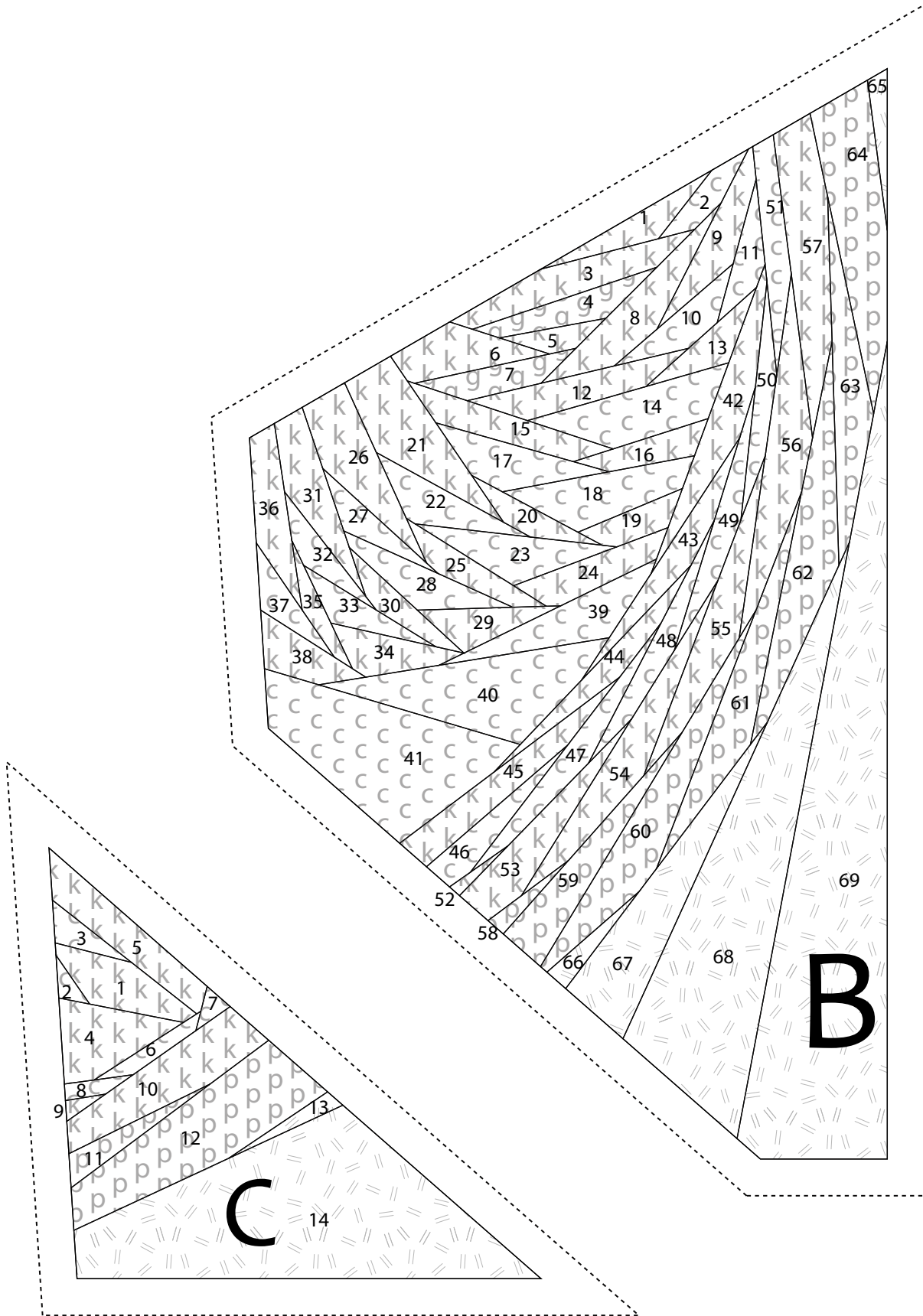

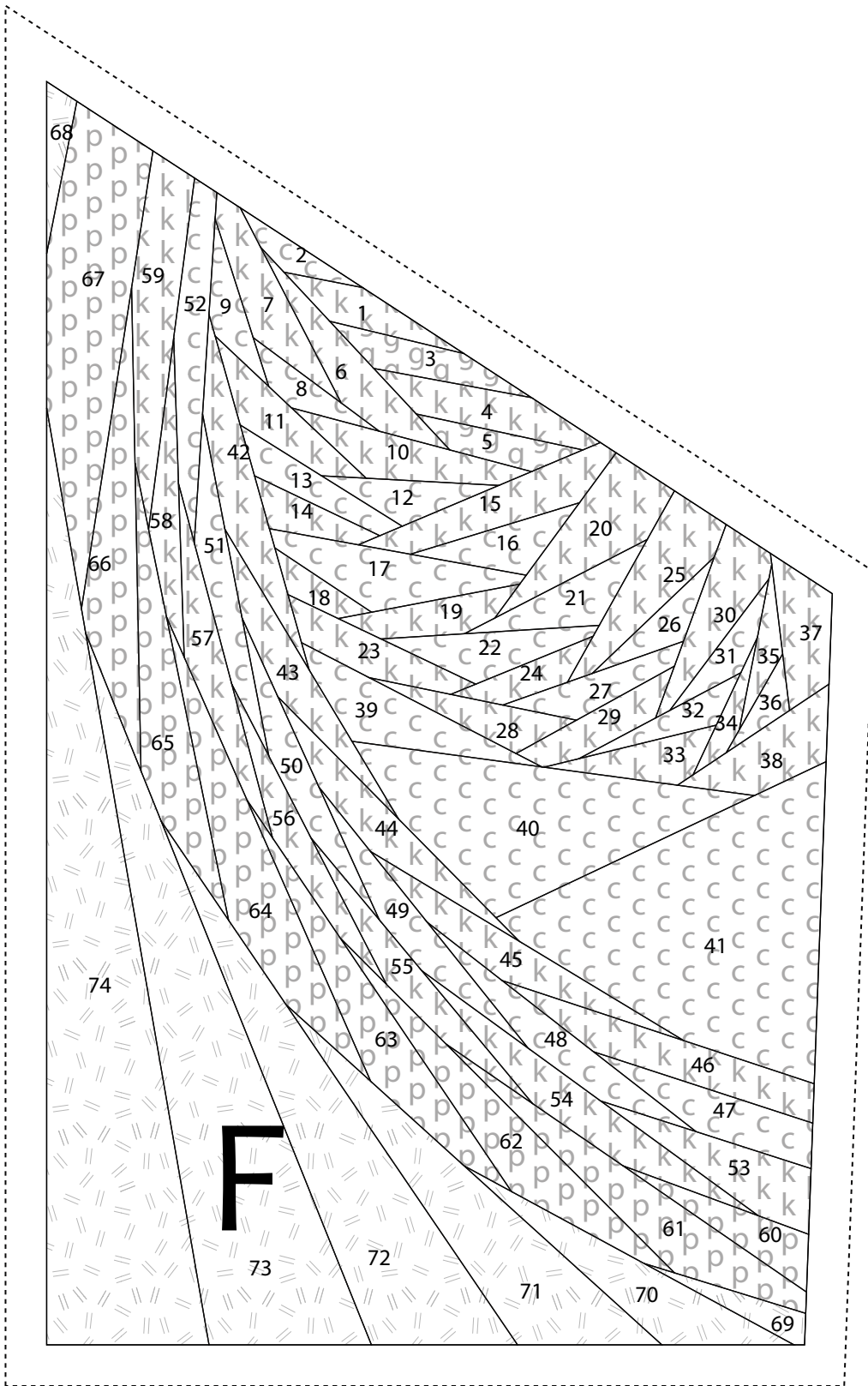

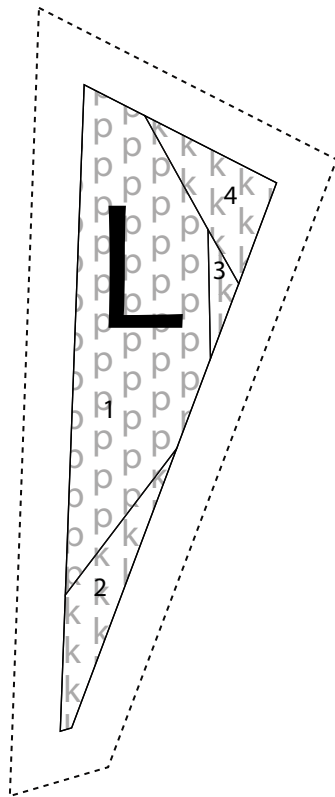
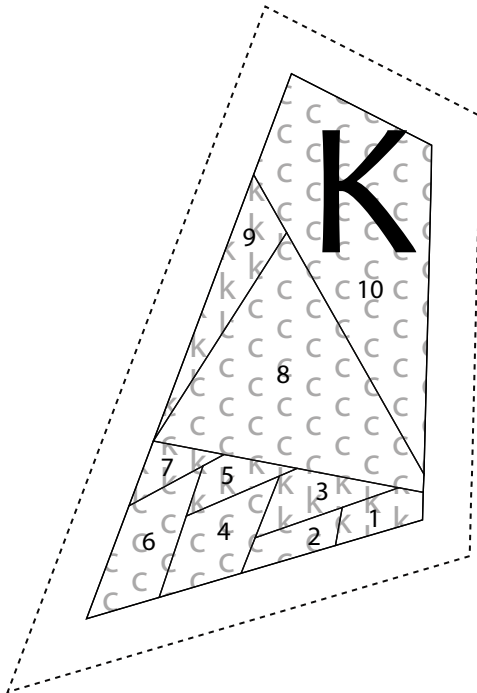
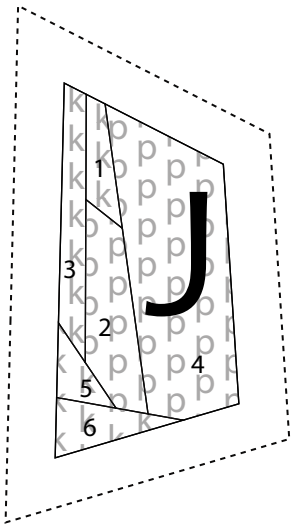
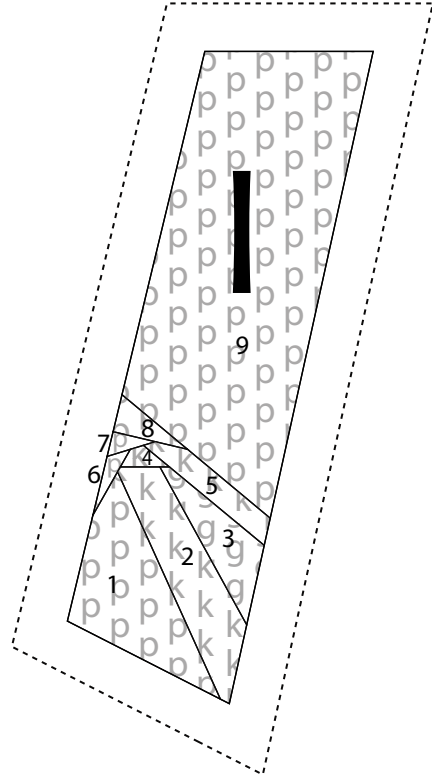
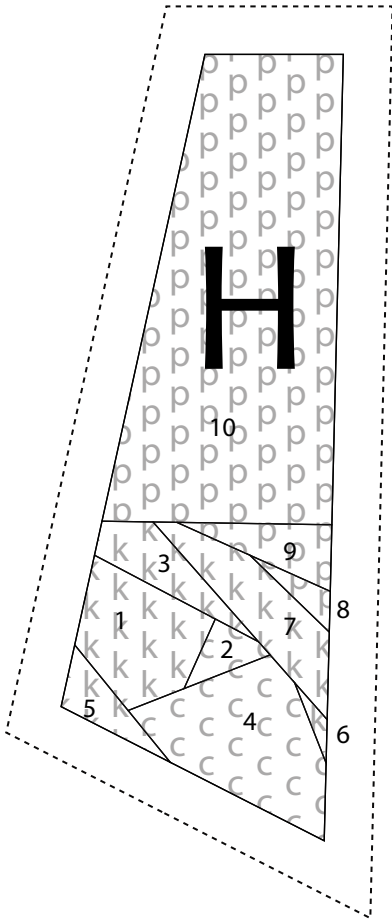
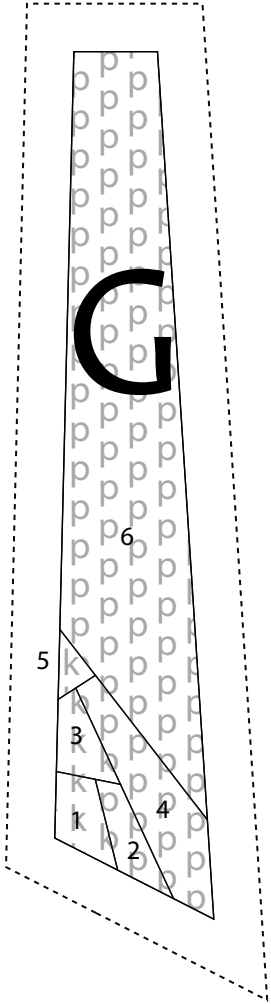

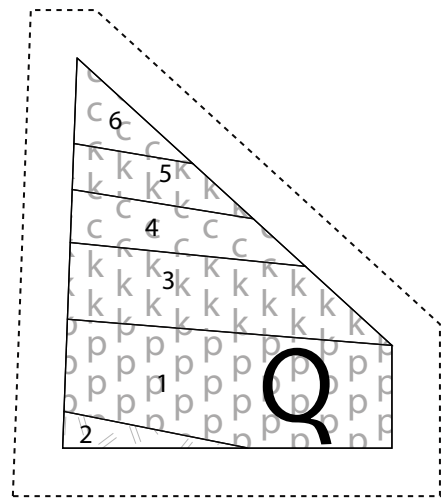
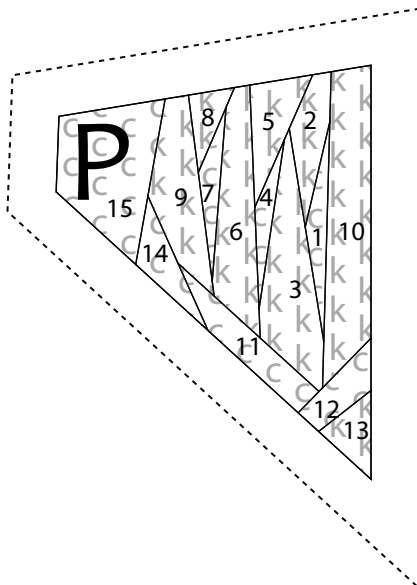
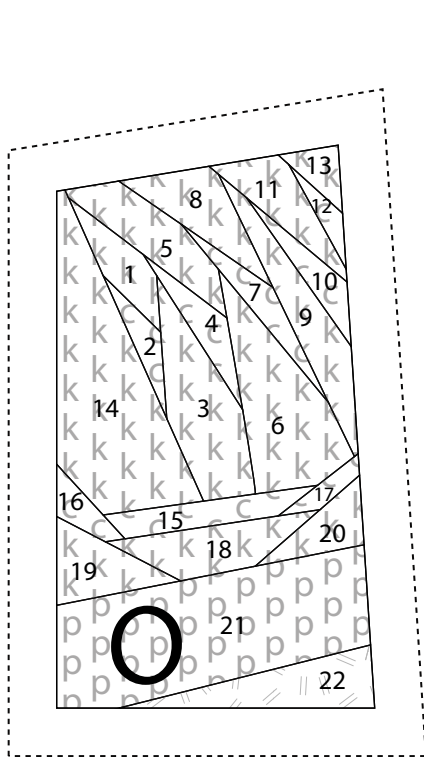
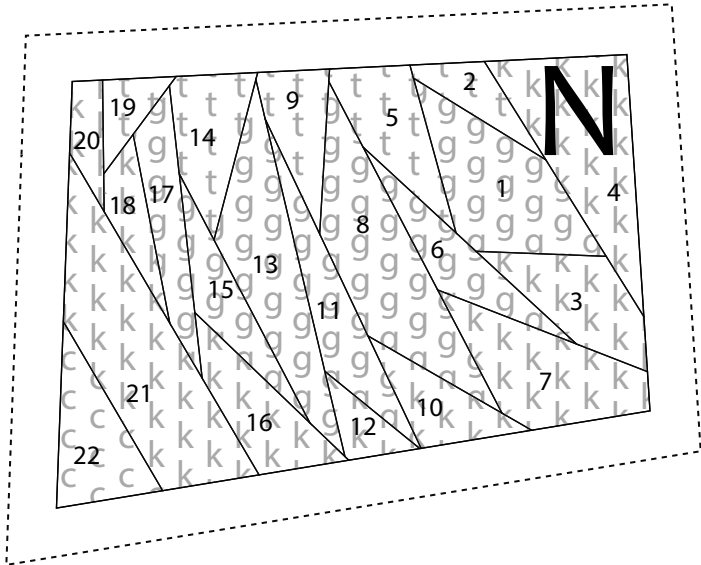
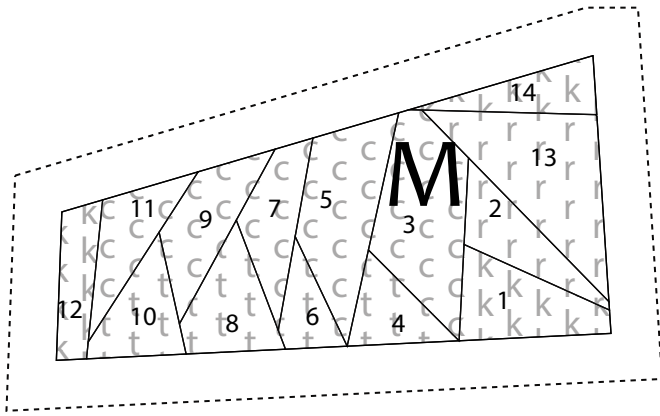

Coloring Page

Print to audition different color schemes for this pattern.

